

Number	Name
1	engine
2	fuel tank parts
3	frame parts
4	4705 electrical machine
5	4705 control panel

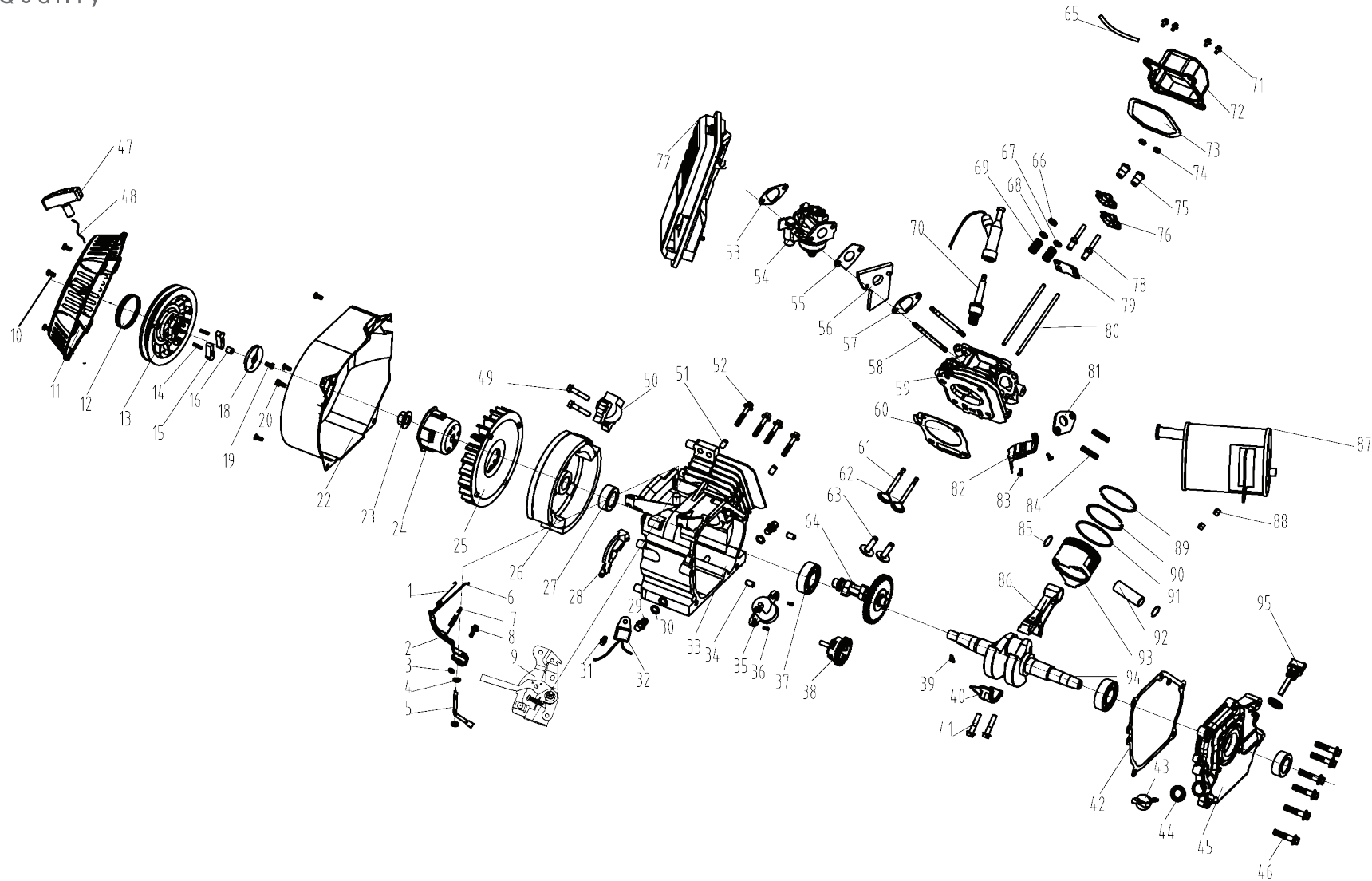

Number	Name
1	pulling spring
2	governor arm
3	nut M6
4	gasket
5	governor lever
6	governor rod
7	governor spring
8	bolt
9	governor ban parts
10	bolt M6x10
11	pulling tray cover
12	spring
13	pulling tray
14	spring
15	starting feet
16	pin
17	clip spring
18	impacted ban
19	bolt M6x15
20	bolt M6x12
21	switch
22	lead wind cover
23	flywheel nut
24	starting claw
25	fan
26	flywheel parts
27	seal,oil
28	windboard
29	oil drain plug
30	gasket
31	M6x12 bolt
32	interdiction organ

Number	Name
33	crankcase parts
34	pin
35	oil sensor
36	M6x15 bolt
37	bearing 205
38	governor gear
39	half-round key
40	connecting rods cover
41	connecting rods bolt
42	crankcase gasket
43	oil gauge
44	gasket
45	crankcase cover
46	bolt M8x35
47	starting handspike
48	starting line
49	M6x25 bolt
50	ignition block parts
51	cylinder head pin
52	cylinder head bolt
53	air cleaner gasket
54	carburetor
55	carburetor gasket
56	carburetor insulator
57	carburetor insulator gasket
58	carburetor bolt
59	cylinder head
60	cylinder head gasket
61	exhaust valve
62	intake valve
63	tappet
64	camshaft

Number	Name
65	rubber hose
66	exhaust valve adjust nut
67	intake valve spring retainer
68	exhaust valve spring retainer
69	valve spring
70	spark plug
71	bolt M6x14
72	cylinder head cover
73	cylinder head cover gasket
74	nut
75	nut
76	rocker arm
77	air cleaner
78	rocker bolt
79	push-rod keep frame
80	push-rod
81	exhaust pipe gasket
82	lead windboard
83	bolt M6x12
84	double bolt
85	piston pin clip spring
86	connecting rods
87	muffler
88	nut M8
89	piston ring 1
90	piston ring 2
91	oil ring
92	piston pin
93	piston
94	crankshaft
95	oil rule

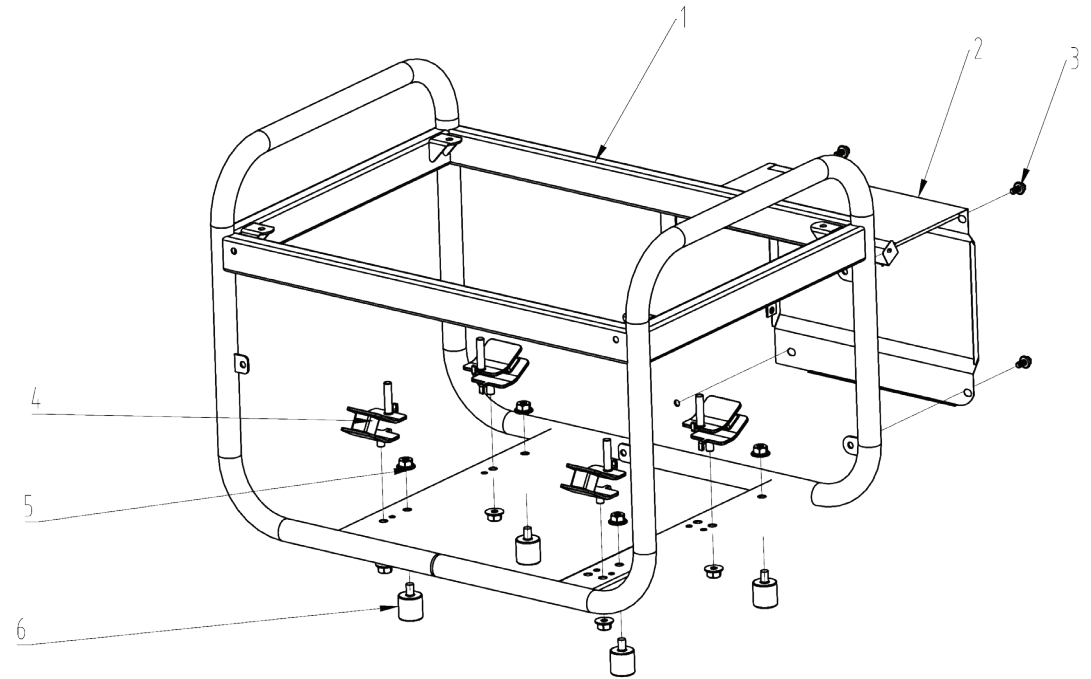
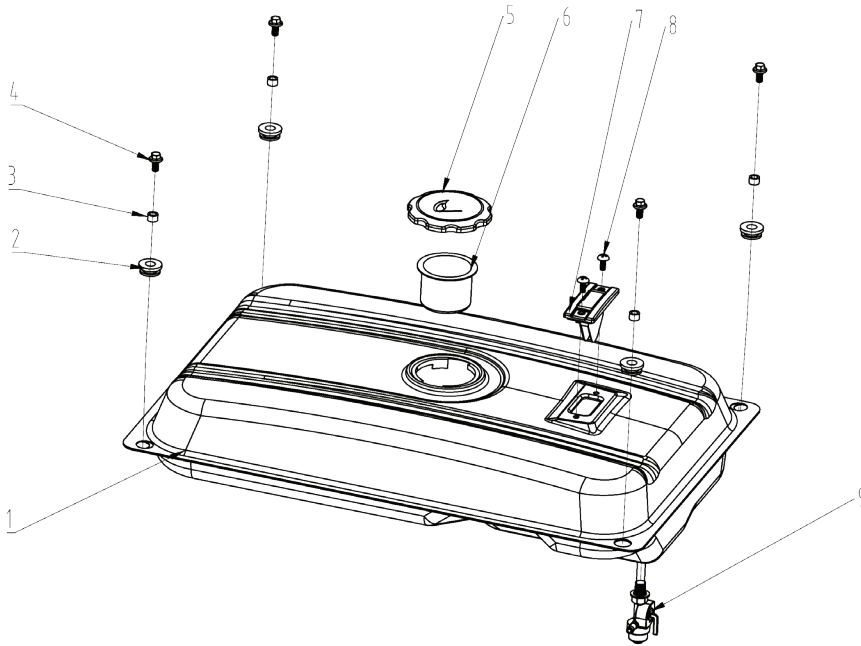

Number	Name
1	fuel tank
2	rubber gasket
3	iron cover
4	bolt M6×25
5	fuel tank cover
6	filter net
7	fuel meter
8	bolt M5×12
9	fuel switch

Number	Name
1	frame
2	guard bar
3	bolt M6×12
4	shake feet
5	nut M8
6	rubber feet

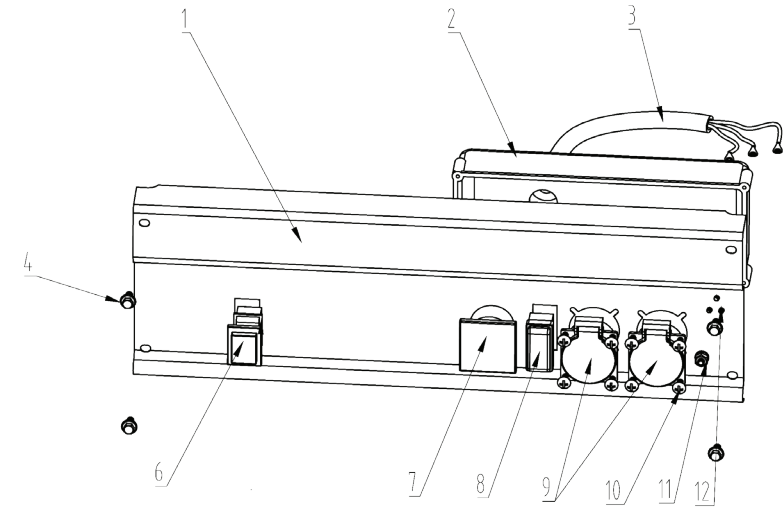
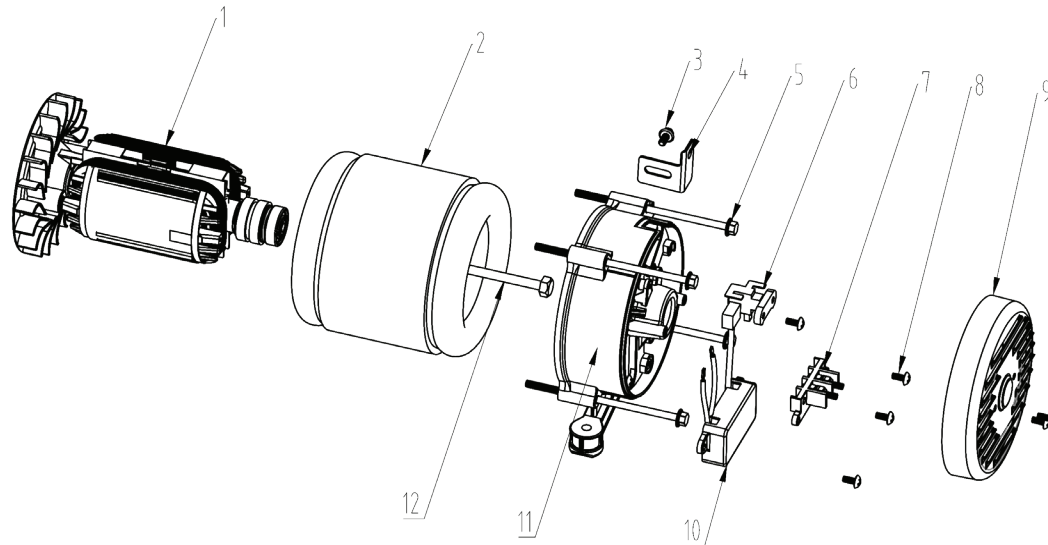

Number	Name
1	rotor (RH-4705)
2	stator (RH-4705)
3	bolt M6x12
4	hang feet
5	stator bolt
6	carbon brush

Number	Name
7	junction box
8	bolt M5x12
9	back cover
10	adjust voltage regulator
11	generator end bell
12	rotor bolt

Number	Name
1	control panel
2	panel back cover
3	inlet wire
4	bolt M6x12
6	switch
7	voltage meter

Number	Name
8	breaker
9	socket
10	bolt M5x10
11	earth bolt
12	DC terminal